

# Scotsman® AC 126

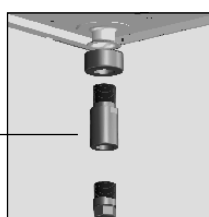

- AC 46
- AC 56
- AC 86
- AC 106
- AC 126**
- AC 176
- AC 206
- AC 226

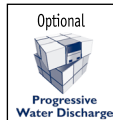
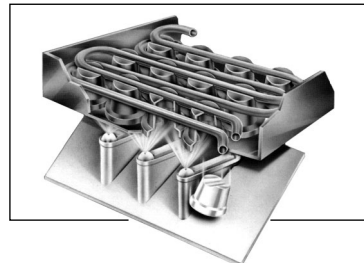

Available as optional

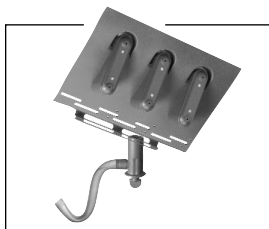

Spray bar quick disconnect

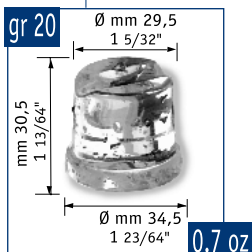

0.7 oz



Patented anti-scale system

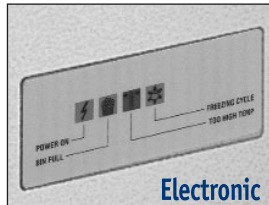

Electronic

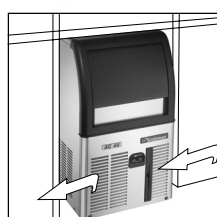

Condenser air filter



Front ON - OFF switch



Hygienic scoop holder



Storage bin antibacterial pouch holder

**Automatic  
Gourmet-Cube  
Ice Machine**

**Machine  
Automatique  
à Glaçons  
Gourmet**

**Automatischer  
Gourmetkegel-  
eisbereiter**

**Màquina  
Automàtica  
Fabricadora  
de Cubitos  
Gourmet**

**Produttore  
Automatico  
di Ghiaccio  
a Cubetti  
Gourmet**

Model	Temperature Range	Production Capacity (per 24h)						Weight (kg)	Weight (lbs)	Height (mm)	Voltage/Phase	Dimensions (mm)	Dimensions (inches)	Compressor
		[kg]	[lbs]	N°*	[kg]	[lbs]	N°*							
AC 126 AS	+C° -C°	71	156	3550	66	145	3300	39	86	1950	230/50/1	680x600x930/1050	26x23x36/41	R 404 a
AC 126 WS	+C° -C°	74	163	3700	70	154	3500	39	86	1950	230/50/1	680x600x930/1050	26x23x36/41	R 404 a

\*Estimate number of medium/large size gourmet cubes.  
Standard legs 120 mm high included.  
Leg extension 60 mm high available as code no. KITLEGSEXT000.  
Optional: PWD System.

[www.scotsman-ice.com](http://www.scotsman-ice.com)  
[www.scotsman-ice.it](http://www.scotsman-ice.it)

**2**  
Years Warranty  
Ans de Garantie  
Jahre Garantie  
Años de Garantía  
Anni di Garanzia

Subject to certain limitations and exclusions  
Assujettie aux limites et exclusions prescrites  
Abhängig von Bestimmten Einschränkungen und Ausnahmen  
Sujeta a algunas limitaciones y exclusiones  
Soggetta ad alcune limitazioni ed esclusioni



ADV-AC 126 - 5/2006

# AC 126

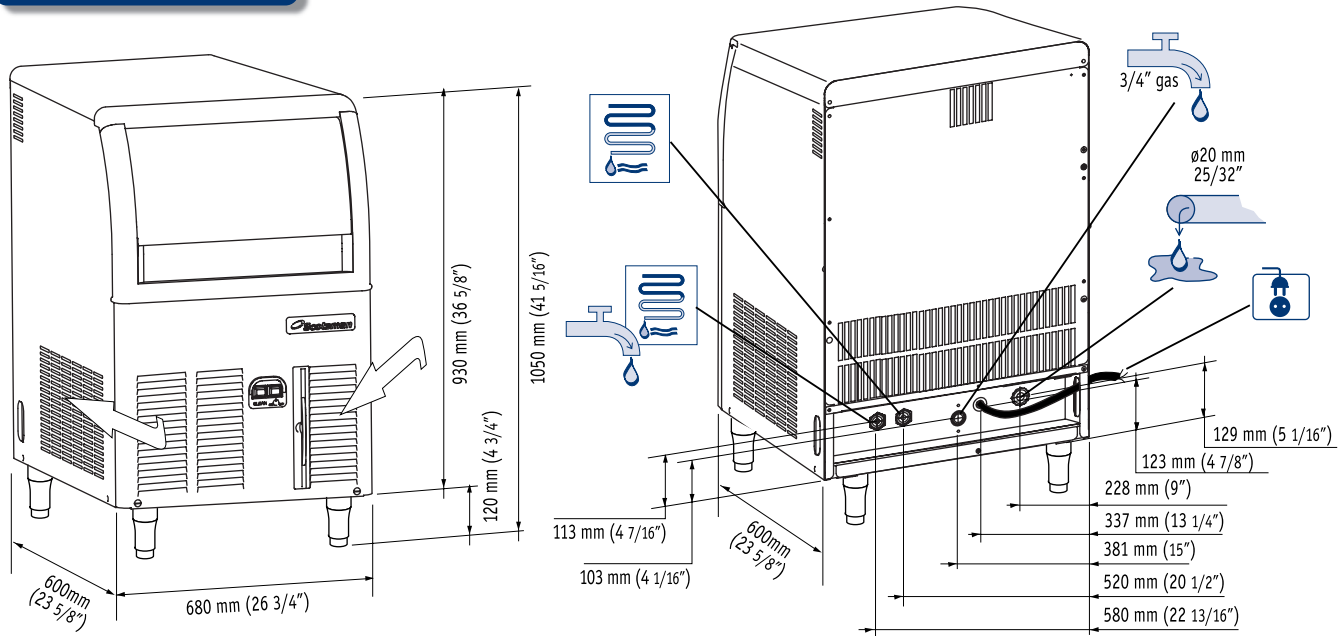

		-°C +°C	[Btu/h] [W]	[Ømm <sup>2</sup> ]	[W]	FUSE [A]	[kWh]	[L/h]	[gal/h]	[kg]	[lbs]	[kg]	[lbs]
AC 126 AS			5357 1570	1,5	600	10	14	7.9	2	65	143	75	165
AC 126 WS			5357 1570	1,5	600	10	11.8	62.5	16.5	65	143	75	165

## AC 126 AIR COOLED



°C	50°	60°	70°	90°	
°F	10°	15°	21°	32°	
10°	71	69.5	68	65	kg
50°	165.5	153	150	143	lbs
21°	67.5	66	64.5	61.5	kg
70°	149	145.5	142	135.5	lbs
32°	59	57.5	56	53	kg
90°	130	127	123.5	117	lbs
38°	53	51.5	50	47	kg
100	117	113.5	110	104	lbs



Machine requires voltage indicated on rating name plate. Failures caused by improper voltage are not considered factory defects. Scotsman products are not designed for outdoor installation. Extended periods of operation at temperatures exceeding the above limitations constitutes misuse under the terms of Scotsman Limited Warranty, resulting in a loss.

## AC 126 WATER COOLED



°C	50°	60°	70°	90°	
°F	10°	15°	21°	32°	
10°	74	71.5	69	64	kg
50°	163	158	162	141	lbs
21°	72.5	70	67.5	62.5	kg
70°	160	154	149	138	lbs
32°	67	64.5	62	57	kg
90°	148	142	137	126	lbs
38°	65	62.5	60	55	kg
100	143	138	132	121	lbs



La machine doit être raccordée conformément au voltage indiqué sur la plaque signalétique. Les éventuels dégâts causés par un non respect de cette consigne ne peuvent être considérés comme des défauts de fabrication. Les machines à glace Scotsman ne sont pas conçues pour être utilisées à l'extérieur. Le fonctionnement prolongé à des températures supérieures ou inférieures aux limites ci-dessus sont considérées comme une mauvaise utilisation dans le cadre de la garantie Scotsman.

Der Eisbereiter benötigt eine Stromspannung gemäß Gerätee-Typenschild. Störungen oder Ausfälle, durch den Betrieb mit falscher Stromspannung sind keine Fabrikationsfehler und fallen nicht unter Garantie. Scotsman Eisbereiter sind nicht für die Installation im Freien geeignet. Der längere Betrieb bei Temperaturen über den obigen Grenzwerten ist eine falsche Anwendung und bedeutet den Verlust der Garantieleistung.

Los requerimientos eléctricos de la máquina están indicados en la placa de características. Los daños causados por voltajes inadecuados no son considerados defectos de fábrica. La máquinas de hielo Scotsman, no están diseñadas para trabajar a la intemperie. Largos periodos de funcionamiento a temperaturas que excedan de las limitaciones indicadas, constituyen maltrato de acuerdo con las observaciones de Scotsman.

La macchina richiede il voltaggio indicato sulla targhetta di identificazione. Danni causati da voltaggi diversi non sono considerati difetti di produzione. I prodotti Scotsman non vanno utilizzati all'aperto. Un prolungato periodo di utilizzo al di fuori delle temperature indicate non è consentito e causa l'automatico decadere della garanzia.



Minimum

10°C (50°F)



Maximum

40°C (104°F)



5°C (41°F)



35°C (95°F)



-10%

+10%



1 BAR

14 psi

5 BAR

70 psi

**Scotsman**® The one the world relies on.  
Ice Systems

Certified ISO 9001:2000

### USA, Canada, Latin America

Scotsman Ice Systems USA  
775 Corporate Woods Parkway  
Vernon Hills, IL 60061  
Ph: (+1) 847 215-4550  
Fax (+1) 847 913-9844  
customer.service@scotsman-ice.com

### Europe

Scotsman Europe-Frimont S.p.A.  
Via Puccini, 22  
20010 Pogliano (Milano) Italy  
Ph: (+39) 02-93960208  
Fax: (+39) 02-93960201  
scotsman.europe@frimont.it

### Asia and Pacific

Scotsman Ice Systems-Frimont S.p.A. (R.O.)  
627A Aljunied Road #04-04 Biztech Centre  
Singapore 389842  
Ph: (+65) 6738 5393  
Fax: (+65) 6738 1959  
scotsice@singnet.com.sg

### China

Scotsman Ice Systems  
(Shanghai) Co., Ltd  
Room 405-407 Jing'an China Tower  
1701 West Beijing Road-200040 Shanghai  
Ph: (+86) 21-62476056-Fax: (+86) 21-62476126  
scotsmansh@online.sh.cn

### Middle East & N. Africa

Scotsman Ice Systems Dubai Office  
P.o. Box 21648  
Sharjah - U.A.E.  
Mobile: Ph: (+971) 505505980  
Fax (+971) 6-5654063  
scotsman@eim.ae

### South Africa

Scotsman Ice Systems SA (PTY) Ltd.  
10, Rhodes Street - Kensington B  
P.o. Box 44 - Riverclub 2149  
Ph: (+27) 11-7898400  
Fax (+27) 11-7898411  
scotsman@telkomsa.net